

# Multi Input Clustering Basics

Haaroon Yousaf

## Multi-input clustering

**A user must own the private key in order to use unspent coins**

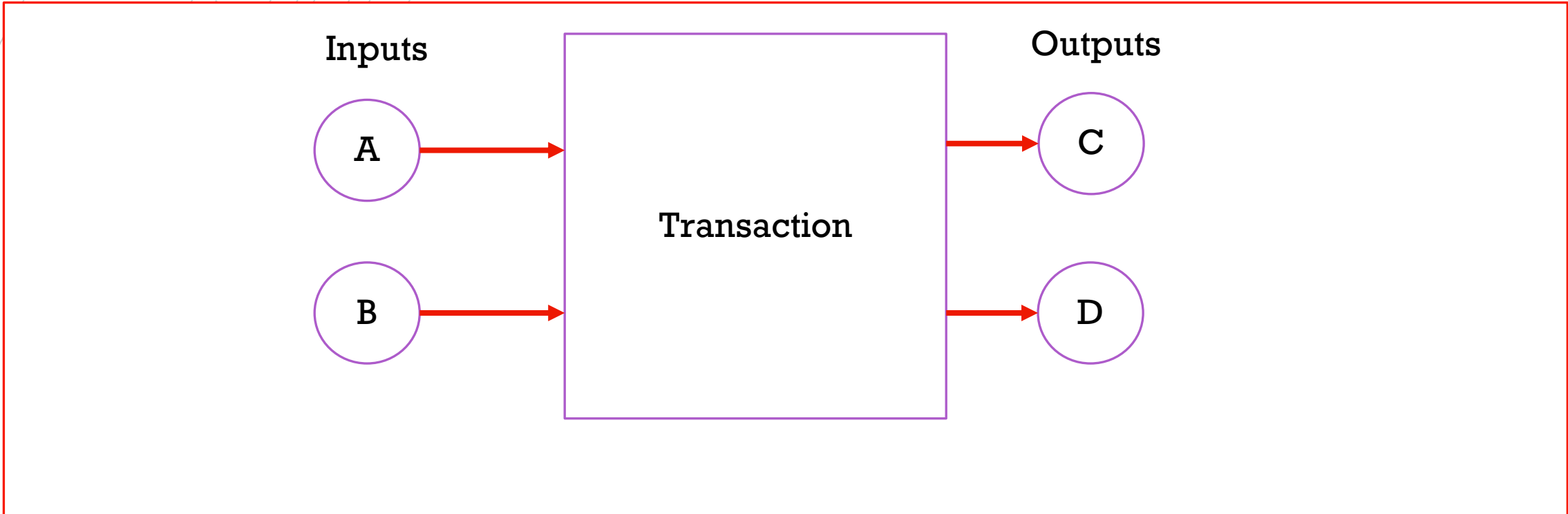

[ed1068c0d9234f6f2c77ebbfdbfe6e7e2bc73e6cedb908dc56a2fd355f067a9](#)

(Fee: 0.000374 BTC - 25.13 sat/WU - 100.54 sat/B - Size: 372 bytes) 2018-06-17 23:51:01

[1AvAH6QHKUc6CEyNxgzjCAnS3YpCepX6fZ](#) (0.01685432 BTC - Output)  
[17XFNCYpLQpSuES2XNJUj4cEruUkSE6N7w](#) (0.01665849 BTC - Output)

➔ [1JYQgd2WDktSzZSJLTqBmcvuf263NEsbB8](#) - (Spent) 0.02255721 BTC  
[1GNYSBQZ374P9NX245L4TMRysgFWxovZV6](#) - (Spent) 0.0105816 BTC

0.03313881 BTC

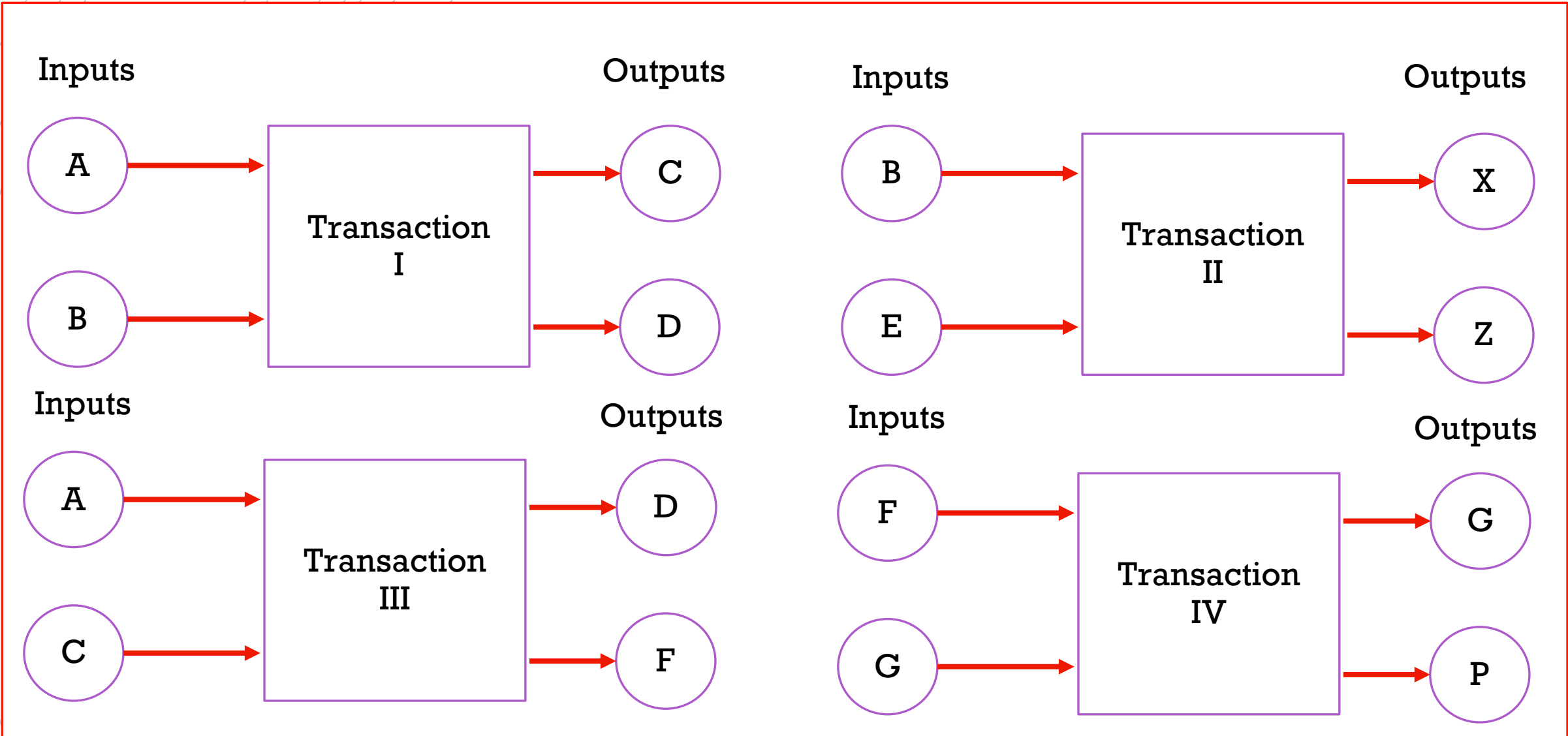

Inputs

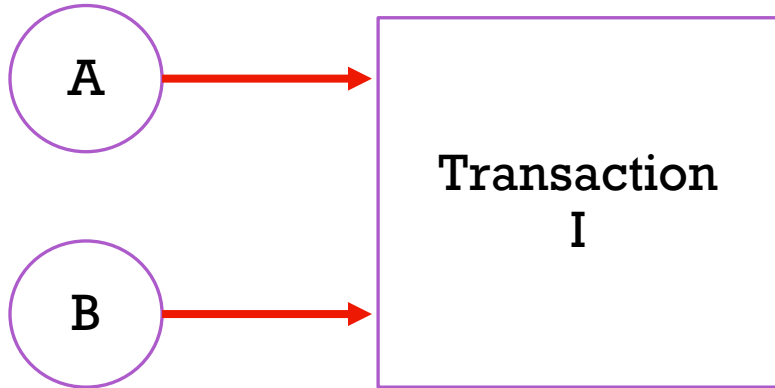

Inputs

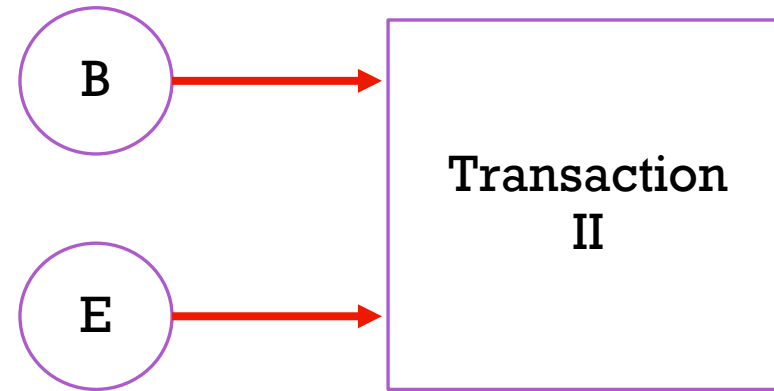

Inputs

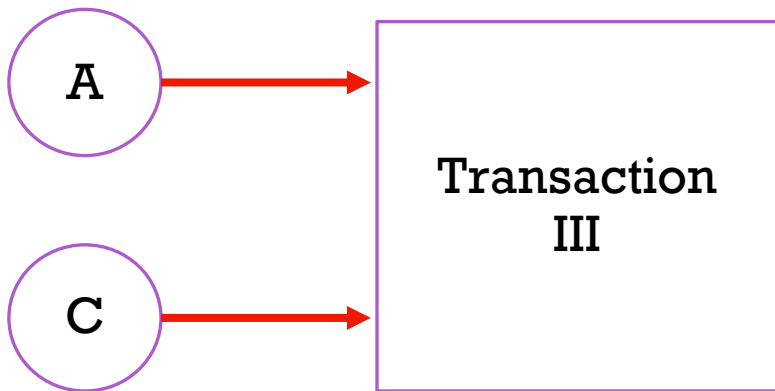

Inputs

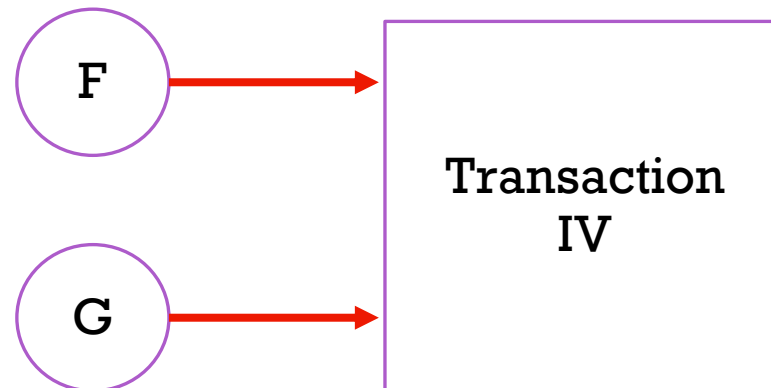

Inputs

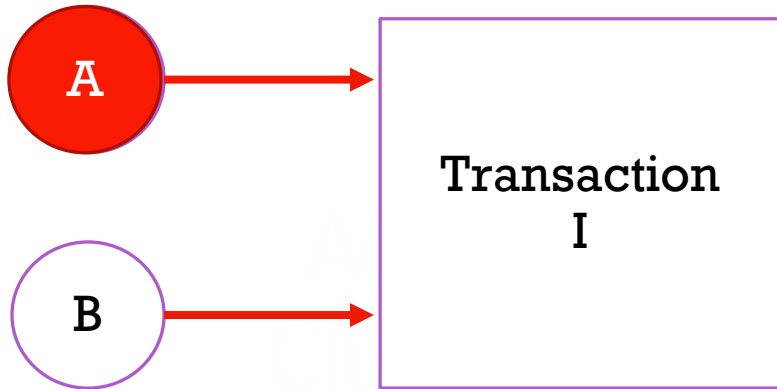

Inputs

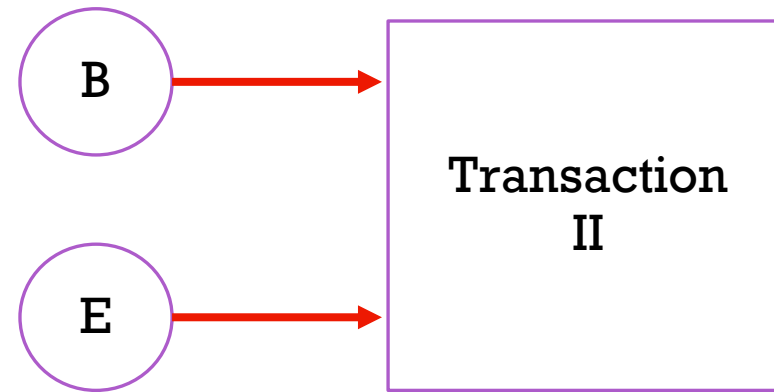

Inputs

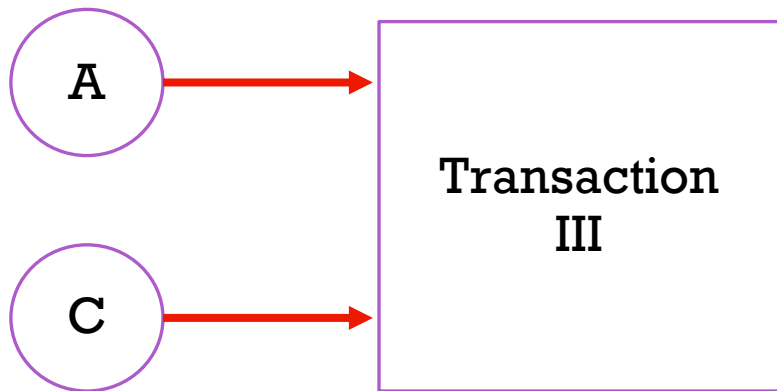

Inputs

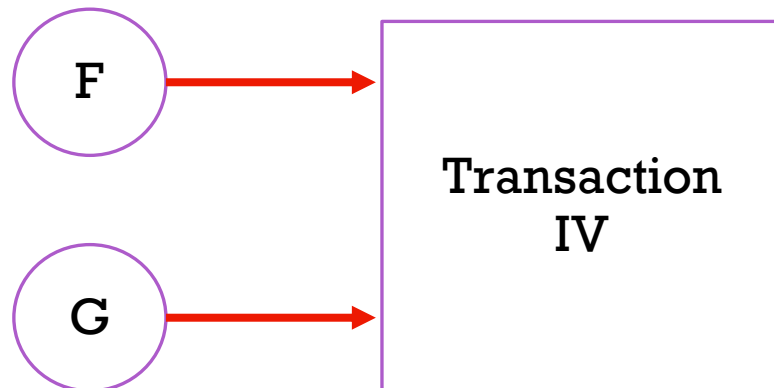

Inputs

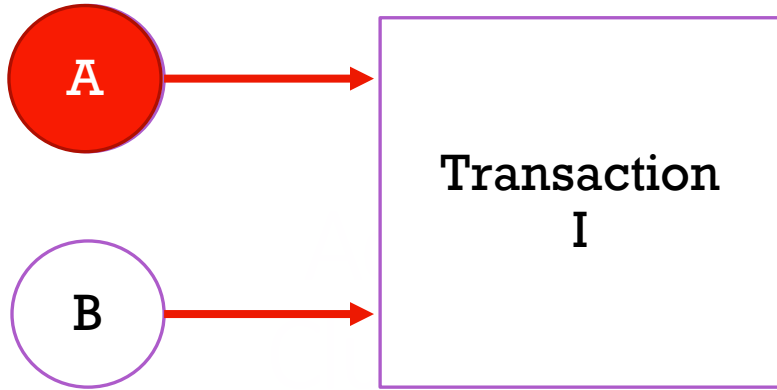

Inputs

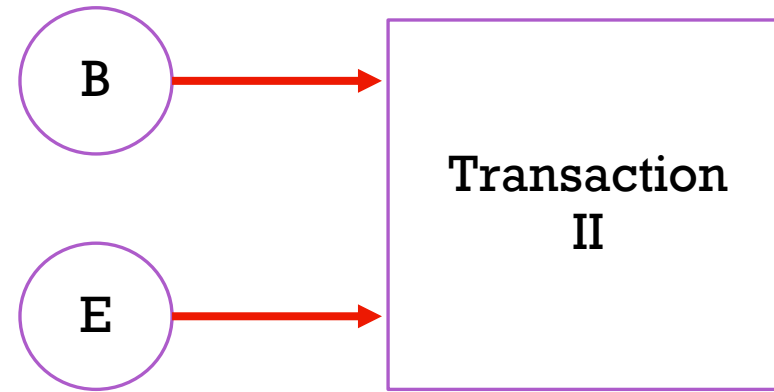

Inputs

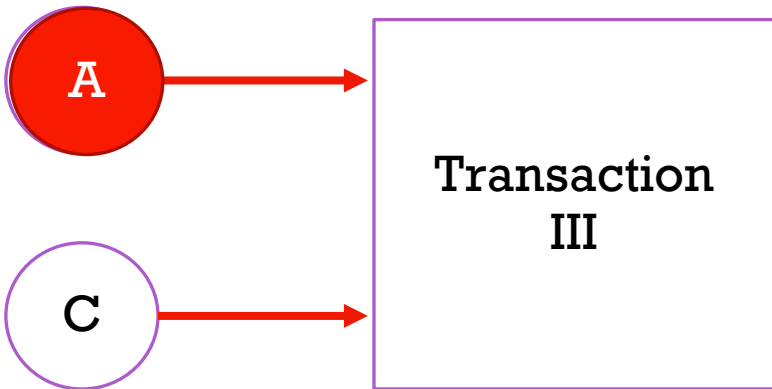

Inputs

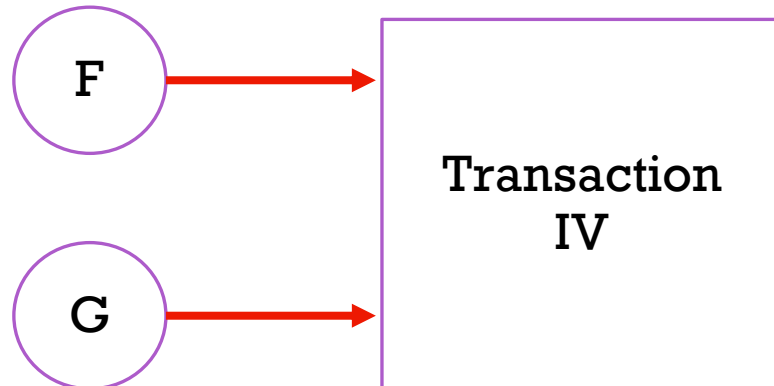

Inputs

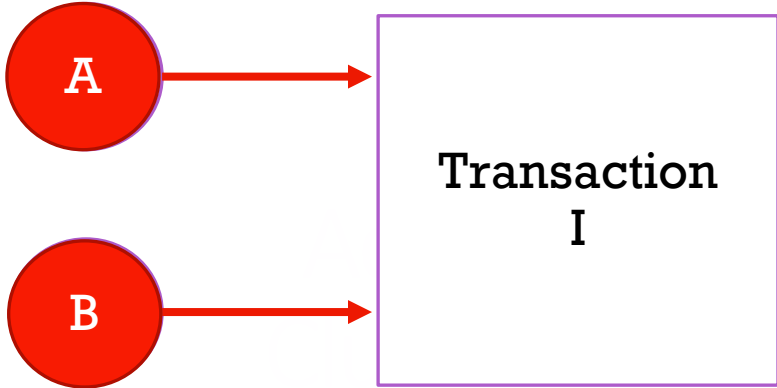

Inputs

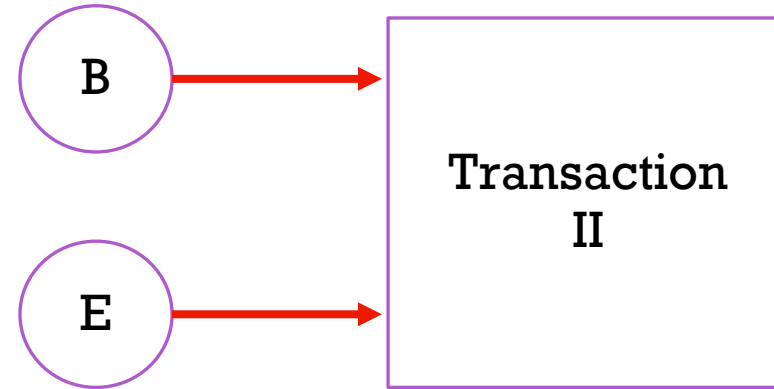

Inputs

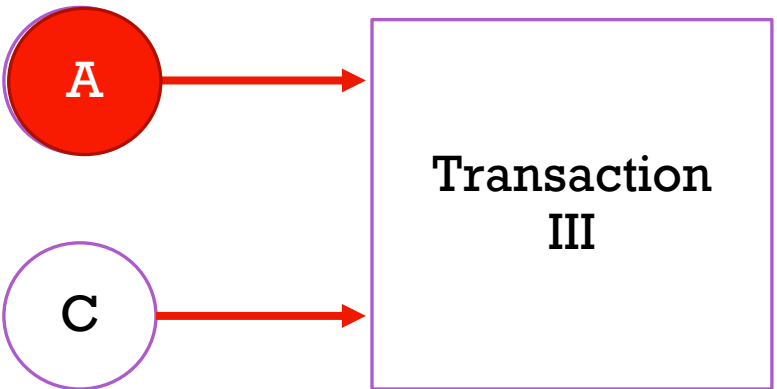

Inputs

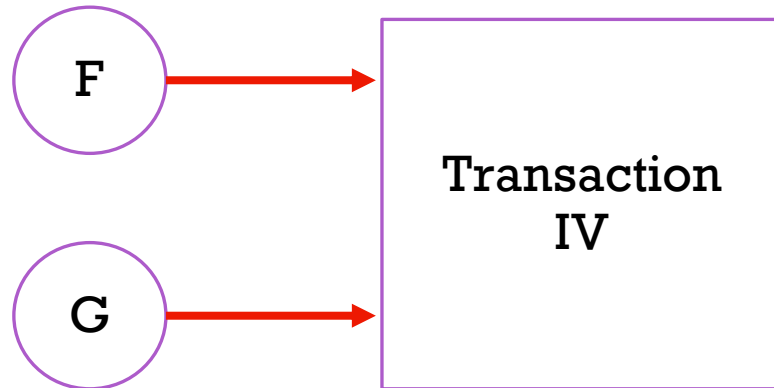



Inputs

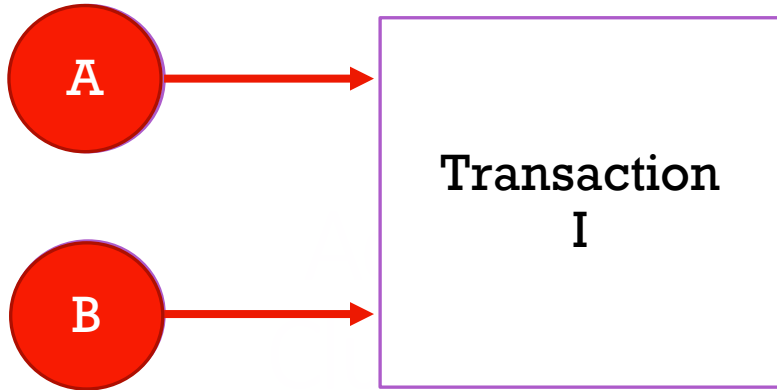

Inputs

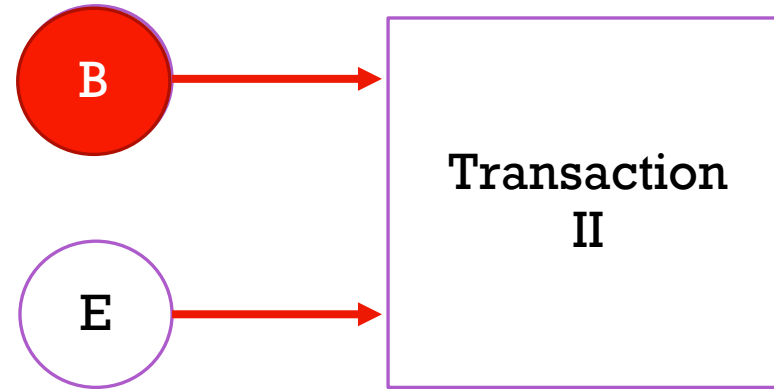

Inputs

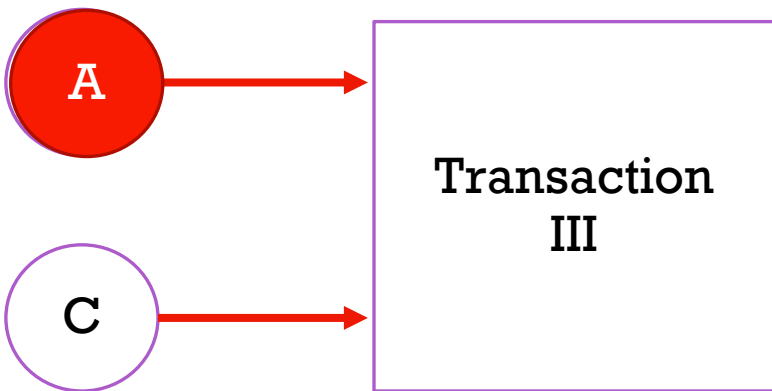

Inputs

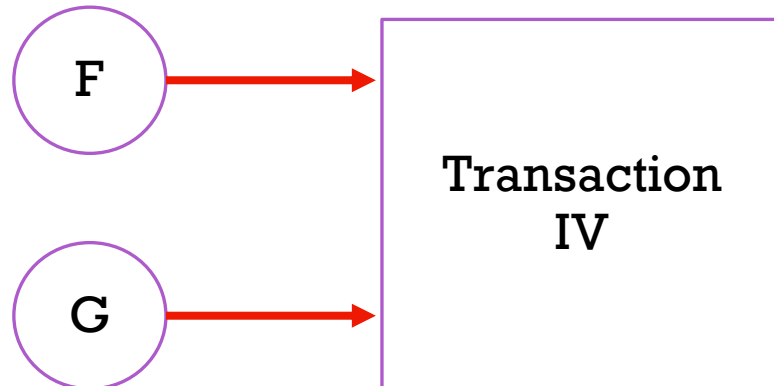

Inputs

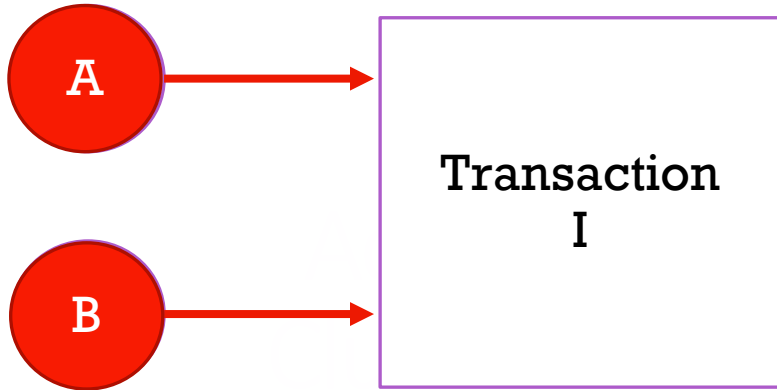

Inputs

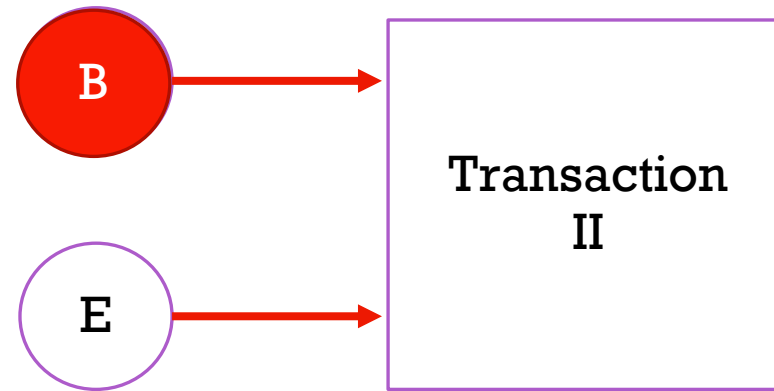

Inputs

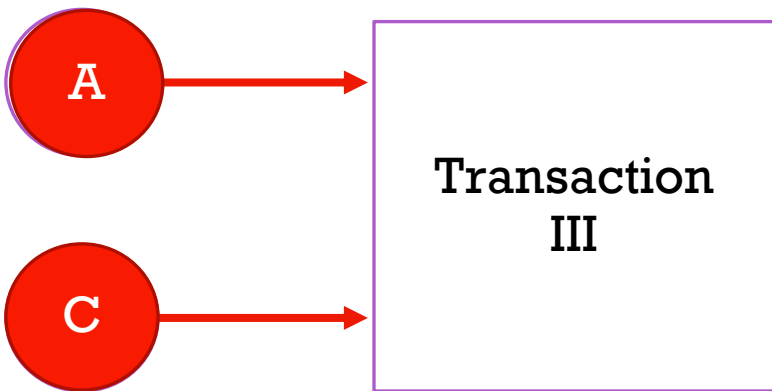

Inputs

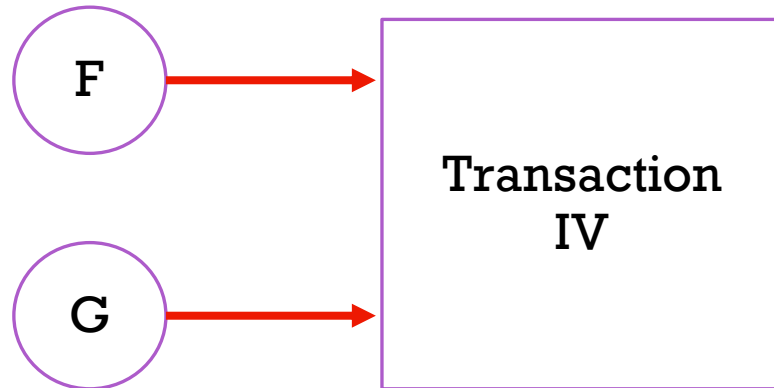

Inputs

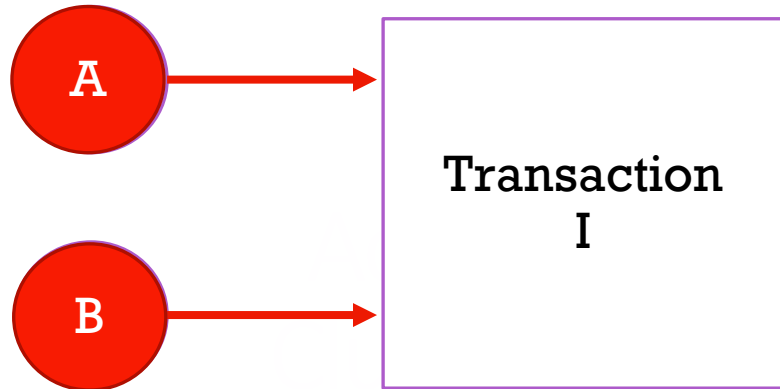

Inputs

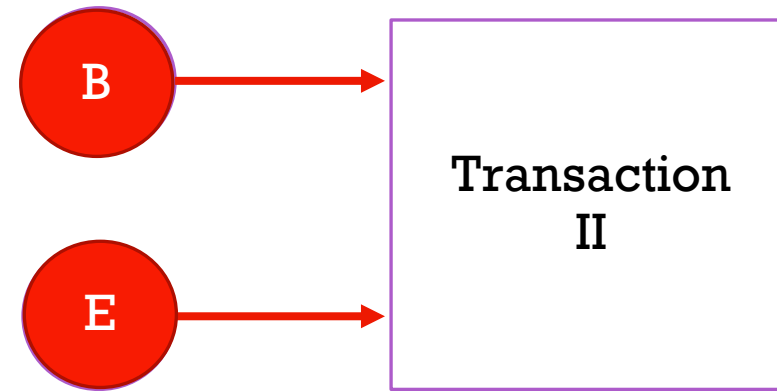

Inputs

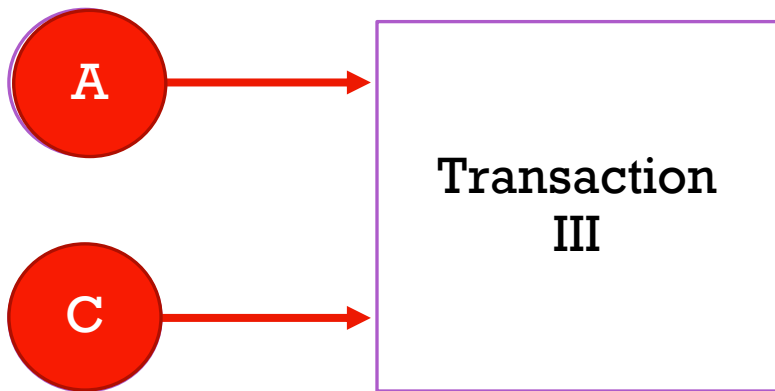

Inputs

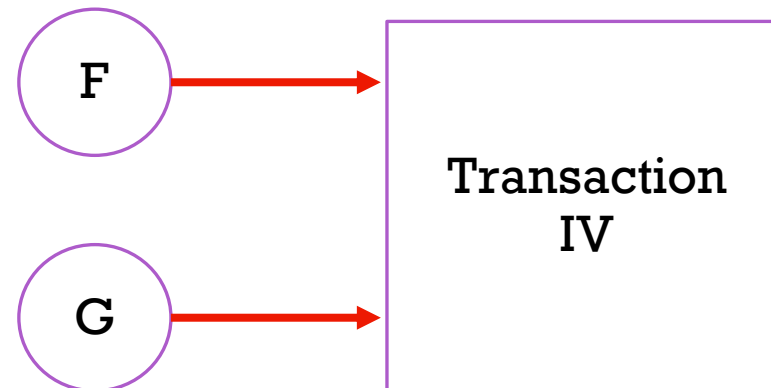

Inputs

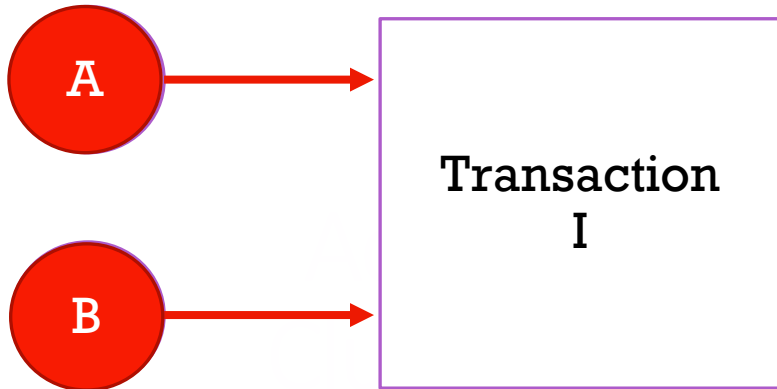

Inputs

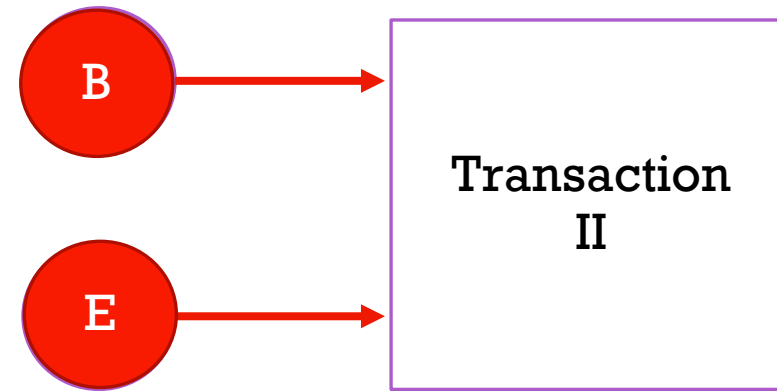

Inputs

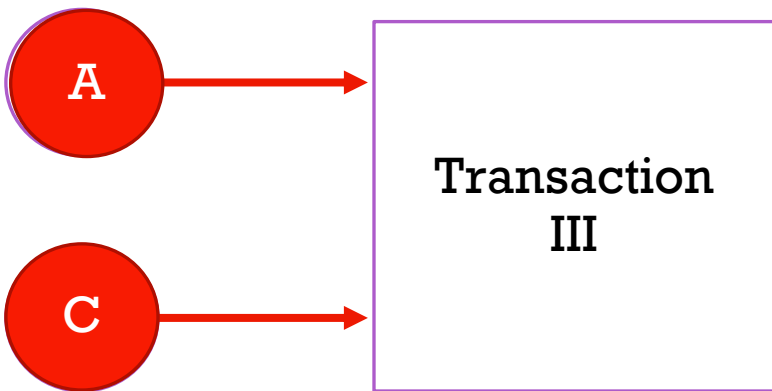

Inputs

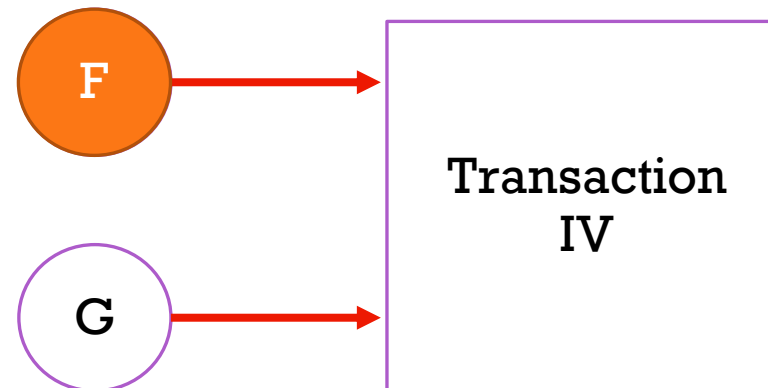

Inputs

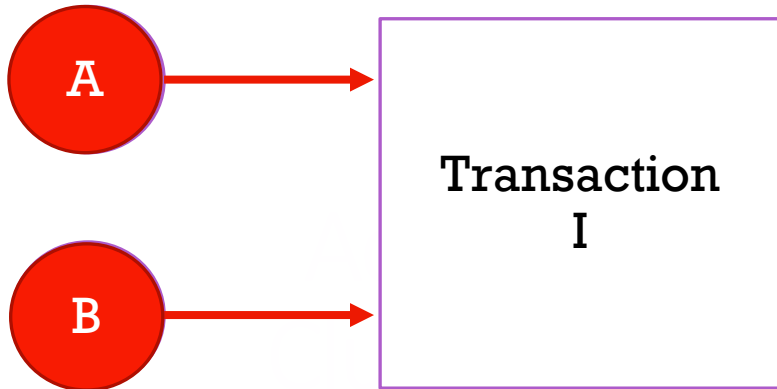

Inputs

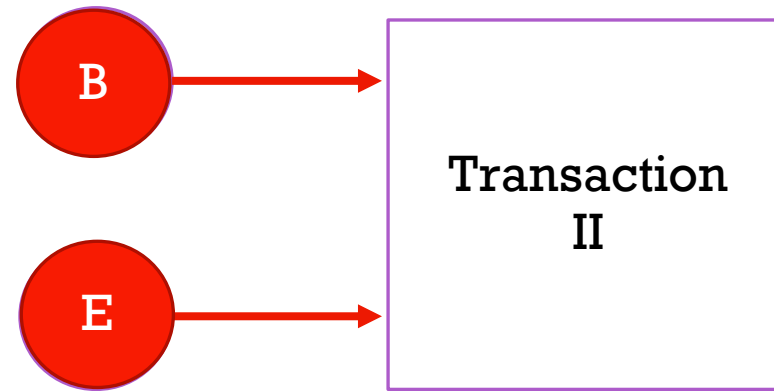

Inputs

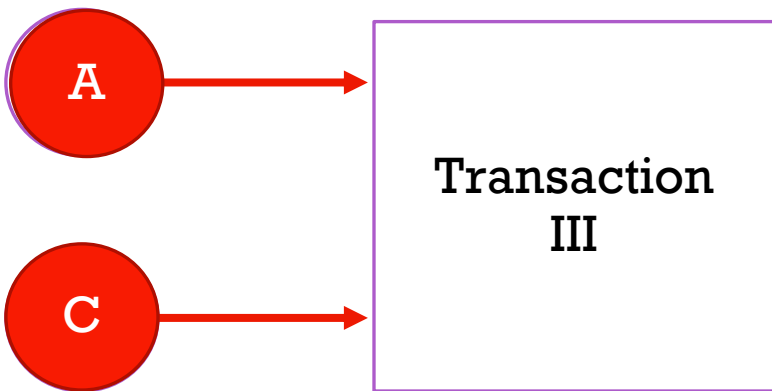

Inputs

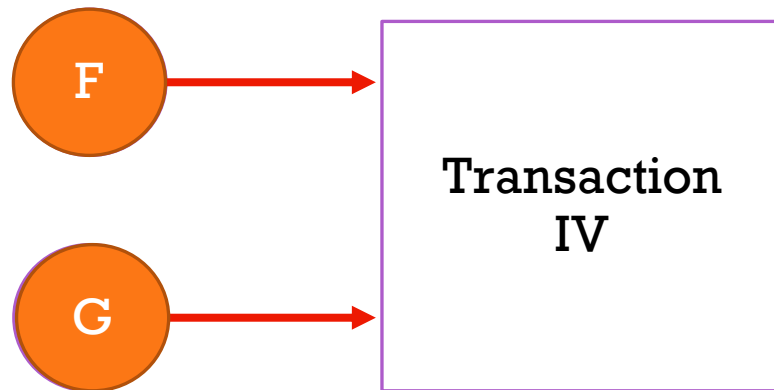

?

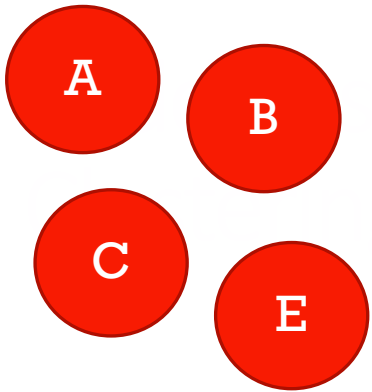

2 distinct clusters

?

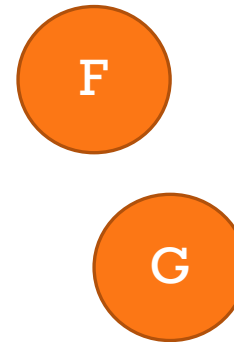

# Tagging

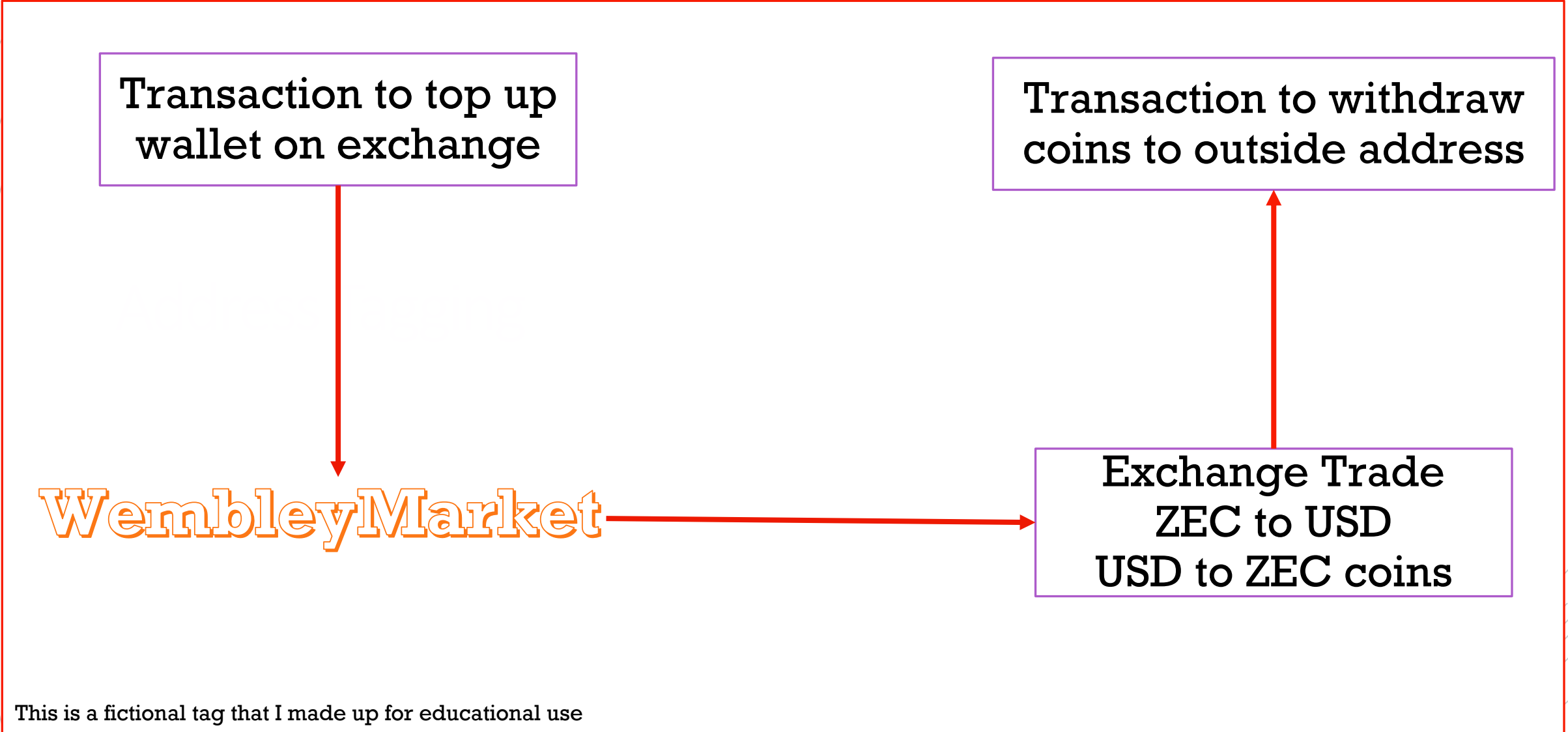

This is a fictional tag that I made up for educational use

Tagging

**You already have the tags in the  
coursework!**



ed1068c0d9234f6f2c77ebdbdfbfe6e7e2bc73e6cedb908dc56a2fd355f067a9

(Fee: 0.000374 BTC - 25.13 sat/WU - 100.54 sat/B - Size: 372 bytes) 2018-06-17 23:51:01

~~1AvAH6QHKUc6CEyNkgzj0An08Yp0epX6fZ (0.01685432 BTC - Output)~~

17XFNCYpLQpSuES2XNJUj4cEruUkSE6N7w (0.01665849 BTC - Output)



1JYQgd2WDktSzZSJLTqBmcvuf263NEsbB8 - (Spent)

0.02255721 BTC

1GNysBQZ374P9NX245L4TMRysgFWxovZV6 - (Spent)

0.0105816 BTC

0.03313881 BTC

Check to see which cluster this address belongs to, that cluster is tagged

This is an example tx for educational use only

# WembleyMarket

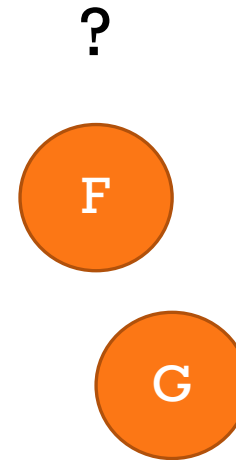
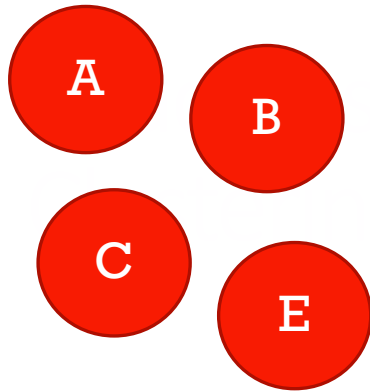

This is a fictional tag that I made up for educational use